

RS

NAUTIC-LINE

Produkte zur Bootspflege

Produits pour l'entretien
des bateaux

Prodotti per la manu-
tenzione delle barche

Boat care products



RIWAX[®]
beauty for cars



Schweiz

RIWAX-Chemie AG

Headquarter

Tannholzstrasse 3
CH-3052 Zollikofen
Tel. +41 (0)31 910 45 45
Fax +41 (0)31 910 45 05
office.ch@riwax.com
www.riwax.com

Niederlande

RIWAX NEDERLAND B.V.

Dieselstraat 13
NL-8263 AE Kampen
Tel. +31 (0)38 333 33 15
Fax +31 (0)38 333 33 16
info@riwax.nl
www.riwax.nl

Ungarn

RIWAX HUNGARIA KFT.

Than Karoly u. 25
HU-1119 Budapest
Tel. +36 (1) 348 01 81
Fax +36 (1) 348 01 82
riwax@riwax.hu
www.riwax.hu

Österreich

Wolfgang GesmbH

Barnabas-Fink-Stasse 11
A-6845 Hohenems
Tel. +43 (0) 5576 72330
Fax +43 (0) 5576 75556
www.autolackprofi.com
office@autolackprofi.com

Belgien

RIANKAR bvba

Industriezone «De Waerde»
Senator A. Jeurissenlaan 1132
BE-3520 Zonhoven
Tel. +32 11 82 16 55
Fax +32 11 81 87 92
riankar.bvba@pandora.be

Frankreich

Sogéric

Bvd des Bassins de Radoub
Cap Pinède
F-13002 Marseille
Tel. +33 491 11 61 38
Fax +33 491 58 52 59
www.intermedsogeric.com
office@intermedsogeric.com

Tschechien

RIWAX spol. s.r.o.

Kralupská 2/47
CZ-16100 Praha 6
Tel. +420 235 316 712
Fax +420 235 316 712
info@riwax.cz
www.riwax.cz

Italien

SISTAR s.a.s.

Via Laboratori Autobianchi 1
IT-20033 Desio (Milano)
Tel. +39 0 362 367 350
Fax +39 0 362 367 352
info@sistar.it
www.sistar.it

Türkei

ASRA KIMYASAL

Turgut Reis Mh. Barbaros Cd.
Tekstil Kent Tc. Mr. A20 Bl. no. 31
TR-34210 Istanbul
Tel. +90 212 438 13 75
Fax +90 212 438 13 76
info@asrakimyasal.com
www.asrakimyasal.com

Luxembourg

Auto-Mécanique sarl

21, rue Robert Krieps
LU-4702 Z. I. Petange
Tel. +352 50 28 78 0
Fax +352 50 28 78 50
contact@auto-mecanique.lu
www.auto-mecanique.lu

Portugal

Artur J.T. Ferreira, Lda

Centro Empresarial da Carriça
Lote 5
PT-4745-312 Muro-Trofa
Tel. +351 229 828 734
Fax +351 229 828 735
sherwin.inkolor@sapo.pt

Inhaltsübersicht

Tipps

Anwendungsschema

Produkte zur Bootspflege

Zubehör

Conseils

Schéma d'application

Consigli

Schema di applicazione

Tips

Application diagram

5

6

**Produits pour l'entretien
des bateaux****Prodotti per la manutenzione
delle barche****Boat care products**

15

Accessoires**Accessori****Accessories**

25





Tipps

Consells

Consigli

Tipps

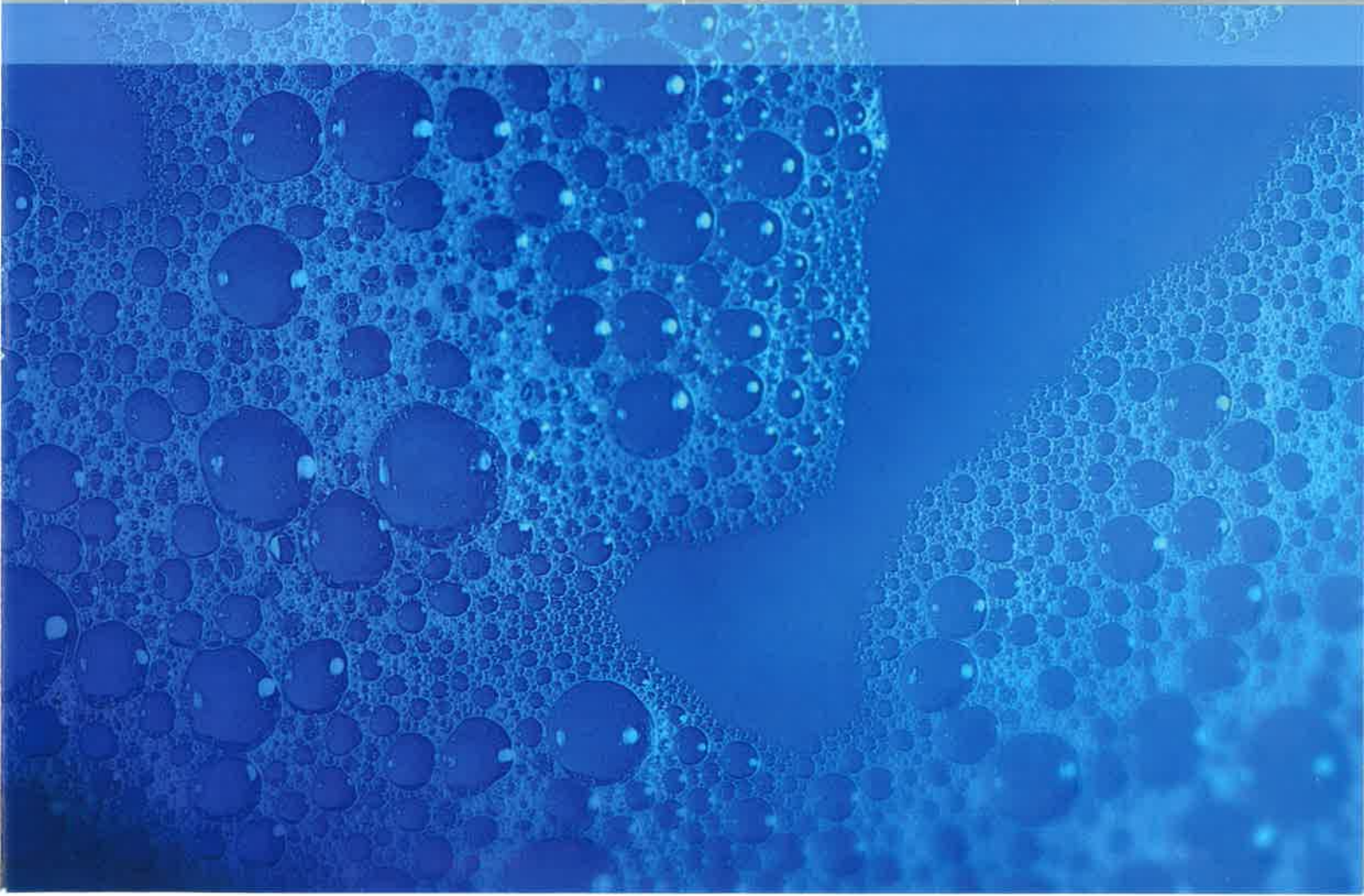



Bootszustand	
helle Bootsoberfläche	Neuzustand oder sehr guter Unterhalt
	Leicht verwittert ohne Tiefenglanz
	Extrem verwittert, Kratzer, sowie matte Oberfläche
dunkle Bootsoberfläche	Neuzustand oder sehr guter Unterhalt
	Leicht verwittert ohne Tiefenglanz
	Extrem verwittert, Kratzer, sowie matte Oberfläche

Waschen

Mattieren

Schritt 1
Boat Clean

Schritt 2



Waschen
Schmutz und Fett mit Boat Clean entfernen.

Mattieren
Mit Schleifscheiben P3000 mattieren bei:

- Repariertem Gelcoat
- Orangenhaut
- Verwittertem oder mattem Gelcoat
- Sichtbaren Umrissen von alten Aufklebern
- Verkrustungen



RS 20 Spray Finish kann bei allen Schritten zusätzlich eingesetzt werden. Ohne Wasser anwendbar. Entfernt effizient Reste von RS Compounds. Kann sowohl auf Gelcoat wie auf Lack angewendet werden. Mit Microfasertuch verarbeiten.

Nach der ersten / zweiten Ausfahrt



Polieren

Schutz

**Schritt 3
RS 02**



Polieren
RS 02 Compound medium
anwenden bei:
• Verwittertem Gelcoat
• Mattem Gelcoat
• Leichten Kratzer

Umdrehungen:
1400 – 2100 U/min.



**Schritt 3A
RS 04**



Polieren
RS 04 Compound fine für das
Auffrischen von Booten

Umdrehungen:
1400 – 2100 U/min.



**Schritt 3B
RS 06**



Hochglanzpolitur
Mit RS 06 Polish polieren für:
• Perfekten Hochglanz
• schnelle Wiederaufbereitung
• Hologrammentfernung

Umdrehungen:
1000 - 2100 U/min.



**Schritt 4
RS 08 / RS10**



Variante 1: Wachsen
RS 08 Star Finish für
die Bootskonservierung

Variante 2: Versiegeln
RS 10 Hard Wax für
längeren Schutz

1. Wachsen



2. Versiegeln



oder Luft
(mind. 6 bar)



oder Luft
(mind. 6 bar)



oder Luft
(mind. 6 bar)



oder Luft
(mind. 6 bar)



oder Luft
(mind. 6 bar)



oder Luft
(mind. 6 bar)



< oder >



oder Luft
(mind. 6 bar)





8

Etat du bateau

Surface de teinte claire

Etat neuf ou excellent entretien

Légère ternissure, brillant sans éclat

Forte ternissure, éraflures, surface dépolie

Surface de teinte foncée

Etat neuf ou excellent entretien

Légère ternissure, brillant sans éclat

Forte ternissure, éraflures, surface dépolie

Après le premier / deuxième passage

Lavage

**Etape 1
Boat Clean**

Lavage

Boat Clean pour nettoyer les salissures et traces de graisse.



1 litre

5 litres



A chaque étape, on peut également faire usage de RS 20 Spray Finish, utilisable sans eau. Supprime efficacement les résidus de RS Compound. Applicable sur gelcoat et sur peinture ou vernis. Utiliser un chiffon à microfibrés.



Dépolir

Etape 2



Dépolir

Poncer avec un disque de granularité P3000 sur :

- Gelcoat après réparation
- Peau d'orange
- Gelcoat terni ou mat
- Traces visibles d'adhésif après décollage d'une étiquette
- Salissures incrustées



ou air
(min. 6 bar)









































ou air
(min. 6 bar)



Lustrage

Protection

<p>Etape 3 RS 02</p> 	<p>Etape 3A RS 04</p> 	<p>Etape 3B RS 06</p> 	<p>Etape 4 RS 08 / RS10</p> 
<p>Lustrage RS 02 Compound medium sur:</p> <ul style="list-style-type: none"> • Enduit gelcoat terni • Enduit gelcoat mat • Eraflures légères <p>Vitesse : 1400 – 2100 tr/min.</p>	<p>Lustrage RS 04 Compound fine pour ravi- ver la peinture des bateaux</p> <p>Vitesse : 1400 – 2100 tr/min.</p>	<p>Lustrage haute brillance RS 06 Polish :</p> <ul style="list-style-type: none"> • Brillant éclatant • Finition „de dernière minute“ • Suppression des hologrammes <p>Vitesse : 1000 – 2100 tr/min.</p>	<p>Variante 1: Traitement à la cire RS 08 Star Finish comme couche de protection.</p> <p>Variante 2: Cire „vitrifiante“ RS 10 Hard Wax pour une protection durable.</p>
 <p>Peau + RS 02 ou bleue</p>	 <p>Peau + RS 04 ou bleue</p>	 <p>blanche + RS 06 ou noir</p>	<p>1. Cirer</p>  <p>noir + RS 08 / RS 10</p> <hr/> <p>2. Dépolir</p>  <p>noir + Capot MF</p>
			 ou air (min. 6 bar) 
			 ou air (min. 6 bar) 
			 ou air (min. 6 bar) 
			 ou air (min. 6 bar) 
			 ou air (min. 6 bar) 
	<p>< OU ></p>		 ou air (min. 6 bar) 



Lavaggio

Levigatura

**Fase 1
Boat Clean**

Fase 2



Lavaggio

Eliminazione di sporco e grasso con Boat Clean.

Levigatura

Levigare con dischi P3000 in caso di:

- gelcoat riparato
- superficie a buccia d'arancia
- gelcoat opaco o deteriorato dagli agenti atmosferici
- tracce visibili di vecchi adesivi
- incrostazioni



1 litro

5 litri



Condizioni della barca

superficie chiara	aspetto nuovo o in buone condizioni di manutenzione		
	leggermente deteriorata dagli agenti atmosferici, senza brillantezza		
	estremamente deteriorata dagli agenti atmosferici, graffiata, opaca		o aria (min. 6 bar)

superficie scura	aspetto nuovo o in buone condizioni di manutenzione		
	leggermente deteriorata dagli agenti atmosferici, senza brillantezza		
	estremamente deteriorata dagli agenti atmosferici, graffiata, opaca		o aria (min. 6 bar)













































RS 20 Spray Finish può essere utilizzato in aggiunta in tutte le fasi. Impiegabile senz'acqua. Rimuove efficacemente i residui di RS Compound. Può essere utilizzato sia su gelcoat sia su vernice. Applicabile con panno in microfibra.

Dopo la prima / seconda uscita

















Lucidatura

Protezione

<p>Fase 3 RS 02</p> 	<p>Fase 3A RS 04</p> 	<p>Fase 3B RS 06</p> 	<p>Fase 4 RS 08 / RS10</p> 
<p>Lucidatura Utilizzare RS 02 Compound medium in caso di:</p> <ul style="list-style-type: none"> • gelcoat deteriorato dagli agenti atmosferici • gelcoat opaco • graffi leggeri <p>Velocità di rotazione: 1400 – 2100 giri/min.</p>	<p>Lucidatura RS 04 Compound fine per ravvivare la barca.</p> <p>Velocità di rotazione: 1400 – 2100 giri/min.</p>	<p>Lucidatura a specchio Lucidare con RS 06 Polish abrasivo per ottenere:</p> <ul style="list-style-type: none"> • una lucentezza perfetta • un rapida ravnatura • l'eliminazione di aloni lucidi <p>Velocità di rotazione: 1000 - 2100 giri/min.</p>	<p>Alternativa 1: Ceratura RS 08 Star Finish per la conservazione della barca</p> <p>Alternativa 2: Sigillatura RS 10 Hard Wax per una protezione a lungo termine</p>
			<p>1. Incerare</p> 
			<p>2. Levigatura</p>   <p>o aria (min. 6 bar)</p> 
			 <p>o aria (min. 6 bar)</p> 
			 <p>o aria (min. 6 bar)</p> 
			 <p>o aria (min. 6 bar)</p> 
			 <p>o aria (min. 6 bar)</p> 
			 <p>o aria (min. 6 bar)</p> 
	<p>< 0 ></p>		 <p>o aria (min. 6 bar)</p> 



		Wash	Dull the surface
		<p>Step 1 Boat Clean</p> <p>Wash Remove dirt and grease with Boat Clean.</p>  <p>1 litre 5 litres</p>	<p>Step 2</p> <p>Dull the surface with P3000 sanding discs in the following cases:</p> <ul style="list-style-type: none"> • Repaired gelcoat • Dimpled skin • Weathered or dull gelcoat • Visible outlines of old stickers • Incrustations 
Boat condition			
Light boat surface	New condition or very good maintenance		
	Lightly weathered without deep gloss		
	Extremely weathered, scratches and dull surface		 <p>or air pressure (min. 6 bar)</p> 
Dark boat surface	New condition or very good maintenance		
	Lightly weathered without deep gloss		
	Extremely weathered, scratches and dull surface		 <p>or air pressure (min. 6 bar)</p> 
		 <p>RS 20 Spray Finish can be used in addition for all steps. Can be used without water. Efficiently removes residue of RS compound. Can be applied both to gelcoat and to paint. Use a micro-fibre cloth to apply.</p>	
After the first / second trip out			

Polish

Protection

**Step 3
RS 02**



**Step 3A
RS 04**



**Step 3B
RS 06**



**Step 4
RS 08 / RS 10**



Polish
Use RS 02 Compound medium in the following cases:
• Weathered gelcoat
• Dull gelcoat
• Light scratches

Speed:
1400 – 2100 rpm.

Polish
Use RS 04 Compound fine for "freshening up" boats

Speed:
1400 – 2100 rpm.

High-gloss polish
Polish with RS 06 Polish for:
• Perfect high gloss
• Fast reconditioning
• Removing holograms

Speed:
1000 - 2100 rpm.

Version 1: Wax
RS 08 Star Finish for boat preservation

Version 2: Seal
RS 10 Hard Wax for longer protection

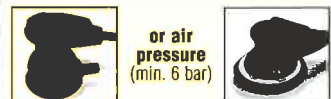
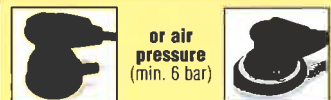
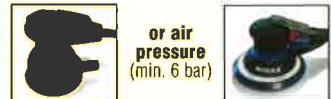
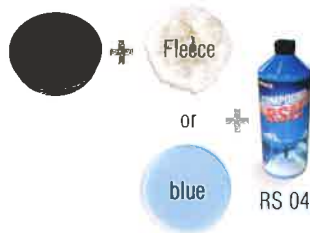

< or >





Produkte zur Bootspflege

Produits pour l'entretien
des bateaux

Prodotti per la manutenzione
delle barche

Boat care products

01



COMPOUND RS 01 FORTE

Entfernt Kratzer mit starken Oxydationen auf Gelcoat schnell und mit gutem Glanz. Geeignet nach dem Abschleifen mit Korngrößen ab 800.

COMPOUND RS 01 FORTE

Elimine rapidement les rayures avec oxydation forte sur gelcoat et donne un bel éclat. Idéal pour repolir après ponçage à l'eau à partir du grain 800.



COMPOUND RS 02 MEDIUM

Für Glanz auf verwitterten und verfärbten Gelcoats oder Lacken. Entfernt Unebenheiten auf reparierten, ausgehärteten Gelcoats. Geeignet nach dem Anschleifen mit Korngrößen 1000 bis 2000.

COMPOUND RS 02 MEDIUM

Pour raviver le brillant du gelcoat ou des peintures ternies et décolorées par les intempéries. Supprime les aspérités des retouches sur gelcoat. Applicable après ponçage à l'émeri granularité 1000 à 2000.



COMPOUND RS 04 FINE

Für Glanz auf verwitterten und verfärbten Gelcoats oder Lacken. Entfernt Unebenheiten auf reparierten, ausgehärteten Gelcoats. Geeignet nach dem Anschleifen mit Korngrößen 2000 (blauer Schwamm) bis 1500 (Lammfell).

COMPOUND RS 04 FINE

Pour raviver le brillant du gelcoat ou des peintures ternies et décolorées par les intempéries. Supprime les aspérités des retouches sur gelcoat. Applicable après ponçage à l'émeri granularité 2000 (mousse bleue) - 1500 (peau d'agneau).



POLISH RS 06

Polish mit guten Reinigungseigenschaften. Für Tiefenglanz. Geeignet für z.B. Gelcoat, Lacke, Plexi- und Acrylglas, Polycarbonat. Auch für dunkle Farben geeignet. Keine Hologrammbildung.

POLISH RS 06

Produit lustrant et nettoyant efficace. Brillant intense. Pour gelcoat, peintures et vernis, plexiglas, verre acrylique, polycarbonate. Convient également pour peintures de teinte foncée. Aspect brillant sans hologramme.

COMPOUND RS 01 FORTE

Elimina rapidamente i graffi con ossidazione forte a gelcoat con un'ottima lucentezza. Ideale anche per lucidare dopo la levigatura a umido a partire dalla grana 800.

COMPOUND RS 01 FORTE

Eliminates rapidly sanding marks on gel coat and gives excellent gloss. Ideal for polishing after sanding with water starting from 800 grits.

Artikel Nr.	Inhalt
No d'articolo	Contenu
No d'article	Contenuto
Article No	Contents
11000-1	1 l

COMPOUND RS 02 MEDIUM

Per rinnovare la brillantezza di vernice e gelcoat leggermente deteriorati dagli agenti atmosferici. Elimina le irregolarità di gelcoat riparati e invecchiati. Adatto dopo la levigatura con abrasivo grana 1000 – 2000.

COMPOUND RS 02 MEDIUM

For achieving a gloss finish on weathered and discoloured gelcoats or paints. Removes irregularities on repaired, hardened gelcoats. Suitable for application after initial sanding with grain size 1000 to 2000 abrasives.

Artikel Nr.	Inhalt
No d'articolo	Contenu
No d'article	Contenuto
Article No	Contents
11001-1	1 l

COMPOUND RS 04 FINE

Per rinnovare la brillantezza di vernice e gelcoat leggermente deteriorati dagli agenti atmosferici. Elimina le irregolarità di gelcoat riparati e invecchiati. Adatto dopo la levigatura con abrasivo grana 2000 (tampone blu) fino a 1500 (cuffia d'agnello).

COMPOUND RS 04 FINE

For achieving a gloss finish on lightly weathered gelcoats or paints. Removes irregularities on repaired, hardened gelcoats. Suitable for application after initial sanding with grain size 2000 (blue sponge) to 1500 (lambskin) abrasives.

Artikel Nr.	Inhalt
No d'articolo	Contenu
No d'article	Contenuto
Article No	Contents
11002-1	1 l

POLISH RS 06

Polish abrasivo con ottime proprietà detergenti. Per una brillantezza profonda. Adatto p. es. per gelcoat, vernici, plexiglas e vetro acrilico, policarbonato. Adatto anche per colori scuri. Non lascia aloni.

POLISH RS 06

Polish with good cleaning properties. For a deep gloss. Suitable for gelcoat, paints, plexiglass and acrylic glass besides polycarbonate for instance. Also suitable for dark colours. No hologramming effects.

Artikel Nr.	Inhalt
No d'articolo	Contenu
No d'article	Contenuto
Article No	Contents
11003-1	1 l

**STAR FINISH RS 08**

Wax für den perfekten Finish mit anhaltender Wirkung. Maschinell (exzentrisch) und von Hand auftragbar. Besonders geeignet für die Bearbeitung von neuen Booten. Verursacht keine Kratzer auf Kunststoff und keine Hologramme.

STAR FINISH RS 08

Cire de finition parfaite à effet durable. Applicable à la machine (excentrique) et à la main. Très indiqué pour les peintures neuves. Sans risque d'éraflure sur les plastiques et sans formation d'hologramme.

**HARD-WAX RS 10**

Wachs für dauerhafte Konservierung mit Tiefenglanz. Neuer High-Tec-Gelcoat-Protector. Maschinell (exzentrisch) und von Hand auftragbar. Dieser Schutz hält über Monate und verleiht Tiefenglanz. Verursacht keine Kratzer auf Kunststoff und keine Hologramme.

HARD-WAX RS 10

Cire de protection durable et brillant intense. Nouvel enduit gélifiant High-Tec-Gelcoat-Protector. Applicable à la machine (excentrique) et à la main. Protège pendant plusieurs mois. Sans risque d'éraflure sur les plastiques et sans formation d'hologramme.

**SPRAY FINISH RS 20**

Sprüh-Reiniger / Politur, reinigt ohne Wasser. Einfache und schnelle Anwendung. Ideal zum Gebrauch als „Finishing Touch“. Kann auf allen Oberflächen eingesetzt werden, auch auf Glas.

SPRAY FINISH RS 20

Produit nettoyant et lustrant à vaporiser, nettoie sans eau. Application facile et rapide. Idéal pour la finition. Pour tout revêtement, également pour le verre.

**WEISSE PASTE RS**

Polierpaste zur Anwendung auf allen Oberflächen. Anwendung sowohl von Hand wie auch mit der Maschine. Entfernt Kratzer und verleiht Gelcoat neuen Glanz.

PÂTE BLANCHE RS

Pâte à lustrer pour tout revêtement. Applicable à la machine et à la main. Supprime les éraflures et ravive le brillant du gelcoat.

STAR FINISH RS 08

Cera per una finitura perfetta con effetto duraturo. Applicabile con macchina rotatorbitale e a mano. Particolarmente adatto per il trattamento di barche nuove. Non graffia la plastica e non lascia aloni.

STAR FINISH RS 08

Wax for the perfect finish with a lasting effect. Can be applied by machine (eccentrically) and by hand. Particularly suitable for use on new boats. Does not leave scratches on plastic nor holograms.

Artikel Nr.	Inhalt
No d'articolo	Contenu
No d'article	Contenuto
Article No	Contents
11004-1	1 l

HARD-WAX RS 10

Cera per una protezione duratura e brillantezza profonda. Nuovo gelcoat-protector ad alta tecnologia. Applicabile con macchina rotatorbitale e a mano. Protegge per mesi e dona una brillantezza profonda. Non graffia la plastica e non lascia aloni.

HARD-WAX RS 10

Wax for durable preservation with a deep gloss. New high-tech gelcoat protector. Can be applied by machine (eccentrically) and by hand. This protective effect lasts for months and results in a deep gloss finish. Does not leave scratches on plastic nor holograms.

Artikel Nr.	Inhalt
No d'articolo	Contenu
No d'article	Contenuto
Article No	Contents
11005-1	1 l

SPRAY FINISH RS 20

Detergente spray, lucida e deterge senz'acqua. Facile e veloce da applicare. Ideale da impiegare come „tocco di finitura“. Applicabile su tutte le superfici, anche su vetro.

SPRAY FINISH RS 20

Spray cleaner / polish, cleans without the use of water. Easy and quick to use. Ideal for a perfect "finishing touch". Can be used on all surfaces, including glass.

Artikel Nr.	Inhalt
No d'articolo	Contenu
No d'article	Contenuto
Article No	Contents
11006-05	0,5 l
11006-6	5 l

PASTA BIANCA RS

Pasta lucidante utilizzabile su tutte le superfici. Applicabile a mano e anche a macchina. Elimina i graffi e dona al gelcoat una nuova brillantezza.

WHITE PASTE RS

Polishing paste for application to all surfaces. Application either manually or by machine. Removes scratches and lends gelcoat a new gloss finish.

Artikel Nr.	Inhalt
No d'articolo	Contenu
No d'article	Contenuto
Article No	Contents
11021-1	1 kg

**BOAT CLEAN RS**

Universal Boot-Reiniger, mit entsprechender Verdünnung auch als Aussen- oder Allzweckreiniger einsetzbar. Sehr guter Motorenreiniger. Gute Reinigungskraft, ohne den Glanz zu beeinträchtigen. Keine Emulsionsbildung.

BOAT CLEAN RS

Nettoyant universel pour bateaux, également utilisable comme nettoyant standard après dilution adéquate. Excellent nettoyant pour moteurs. Bonne aptitude détergente sans ternir le brillant. Produit non émulsionnant.

**WAX SHAMPOO RS**

Waschen und Wachsen in einem Arbeitsgang. Wax-Shampoo entfernt Fett und Öl auf Gelcoat oder Lack, ohne den Gelcoat anzugreifen. Wax Shampoo verleiht beim Waschen neuen Glanz.

WAX SHAMPOO RS

Pour nettoyer et lustrer en même temps. Wax-Shampoo supprime les traces de graisse et d'huile sur gelcoat ou peintures et vernis, sans risque d'éraflures. Wax Shampoo ravive le brillant pendant le nettoyage.

**CABIN CLEAN RS**

Starker Innenreiniger für Boote. Geeignet für das Interieur, das Cockpit, Innenverkleidungen, Kunststoffe, Kunstleder (kein Echtleder) etc. Entfernt mühelos Schmutz und Nikotin und andere Rückstände.

CABIN CLEAN RS

Puissant nettoyant pour l'intérieur des bateaux. Nettoyage du cockpit, revêtements intérieurs, matières plastiques, similicuir (à l'exception du cuir véritable), etc. Supprime facilement et intégralement les traces de salissures et de nicotine.

**GLASS CLEAN RS**

Für schnelle, klare Sicht. Reinigt schnell und mühelos Bootsfenster, Glasflächen, Spiegel, Wandplatten, sanitäre Räume etc. Entfernt Fett und Nikotin. Keine Streifenbildung.

GLASS CLEAN RS

Vitres transparentes en un instant. Nettoyage facile et rapide des fenêtres de bateaux, surfaces vitrées, miroirs, parois, espaces sanitaires, etc. Supprime les traces de graisse et de nicotine. Sans formation de stries ou d'auréoles.

BOAT CLEAN RS

Detergente universale per barche, con diluizione specifica utilizzabile anche come detergente per esterni o detergente universale. Ottimo per la pulizia del motore. Buona capacità detergente senza intaccare la brillantezza. Non forma emulsioni.

BOAT CLEAN RS

Universal boat cleaner. Can also be used as an outdoor cleaning agent or all-purpose cleaning agent if diluted accordingly. Very good engine cleaner. Good cleaning action without impairing gloss. Does not form emulsions.

Artikel Nr.	Inhalt
No d'articolo	Contenu
No d'article	Contenuto
Article No	Contents
11022-1	1 kg
11022-6	5 kg
11022-20	21 kg
11022-200	200 kg

WAX SHAMPOO RS

Lavare e incerare in una sola operazione. Wax-Shampoo elimina il grasso e l'olio da gelcoat o vernice, senza intaccare la superficie. Wax-Shampoo dona una nuova brillantezza ad ogni lavaggio.

WAX SHAMPOO RS

Washing and waxing in one operation. Wax Shampoo removes grease and oil on gelcoat or paint, without attacking the gelcoat. Wax Shampoo lends the surface a new gloss when washing.

Artikel Nr.	Inhalt
No d'articolo	Contenu
No d'article	Contenuto
Article No	Contents
11023-1	1 kg

CABIN CLEAN RS

Potente detergente per interni specifico per barche. Adatto per gli ambienti interni, il cockpit, i rivestimenti interni, plastica, pelle sintetica, ecc. Elimina efficacemente tracce di sporco e nicotina ed altri residui.

CABIN CLEAN RS

Strong interior cleaner for boats. Suitable for the interior, cockpit, interior panelling, plastics and synthetic leather (but not for genuine leather) etc. Effortlessly removes dirt and nicotine besides other residue.

Artikel Nr.	Inhalt
No d'articolo	Contenu
No d'article	Contenuto
Article No	Contents
11024-05	0,5 l
11024-12	10 l
11024-20	20 l

GLASS CLEAN RS

Per una visuale chiara e limpida. Pulisce in modo rapido e senza fatica i finestrini della barca, le superfici in vetro, i pannelli delle pareti, gli ambienti sanitari, ecc. Elimina le tracce di grasso e nicotina. Non lascia aloni.

GLASS CLEAN RS

For fast, clear visibility. Quickly and effortlessly cleans boat windows, glass surfaces, mirrors, all panels and both washroom compartments and sanitary compartments etc. Removes grease and nicotine. Does not cause streaking.

Artikel Nr.	Inhalt
No d'articolo	Contenu
No d'article	Contenuto
Article No	Contents
11025-05	0,5 l
11025-12	10 l
11025-20	20 l



SURFACE CLEAN RS

Eignet sich hervorragend zur Entfernung von Kalkablagerungen am Gelcoat und zur Reinigung von Teakholz. Mit diesem Reinigungsmittel wird Ihr Teakholz wieder schön sauber und sieht aus wie neu.

SURFACE CLEAN RS

Ce détergent convient non seulement pour supprimer les traces de tartre, mais également pour le nettoyage du bois de teck. Avec ce produit nettoyant, le bois de teck retrouve son aspect initial.



WAX POLISH RS

Beseitigt kleinere Beschädigungen, bringt Glanz zurück. Mit schützendem Wachs.

WAX POLISH RS

Cire de lustrage, permet de gommer les petites éraflures superficielles et/ou de restituer le brillant d'origine.



ANTI FREEZE RS

RS Anti Freeze schützt das Trinkwassersystem, Wassertanks, Toiletten etc. gegen Frost. Beugt der Kalkbildung vor und greift Gummi, Kunststoffe und Metalle nicht an. Auch geeignet für Motoren mit Alu-Kühlsystem und -Zylinderkappen. Nicht giftig und biologisch abbaubar.

ANTI FREEZE RS

RS Anti Freeze protège le système d'eau potable, réservoirs, toilettes etc. contre la gelée. Préventive à la formation de calcaire, n'attaque ni le caoutchouc, les matières en plastiques ni les métaux. Convenable aux moteurs à radiateurs en alu ainsi qu'aux couvercles de cylindres en alu. Non toxique et biodégradable.

SURFACE CLEAN RS

Eccellente per eliminare i depositi di calcare su gelcoat e per la pulizia del legno di tek. Con questo prodotto detergente, il vostro legno di tek tornerà perfettamente pulito e come nuovo.

SURFACE CLEAN RS

For the removal of lime scum on gelcoat and the cleaning of teak-wood. Your teak looks like new, clean and beautiful.

Artikel Nr.	Inhalt
No d'articolo	Contenu
No d'article	Contenuto
Article No	Contents
11009-05	0,5 l

WAX POLISH RS

Ripara piccoli graffi, ripristina l'originale brillantezza. Con cera protettiva.

WAX POLISH RS

Removes small scratches and brings back original gloss. Contains protective waxes.

Artikel Nr.	Inhalt
No d'articolo	Contenu
No d'article	Contenuto
Article No	Contents
11008-05	0,5 l

ANTI-FREEZE RS

RS Anti Freeze protegge l'impianto d'acqua potabile, i serbatoi d'acqua, la toilette ecc. dal gelo. Previene la formazione di calcare e non è aggressivo su gomma, plastica e metalli. Idoneo anche per motori con sistema di raffreddamento e calotte cilindri in alluminio. Atossico e biodegradabile.

ANTI-FREEZE RS

Protects the drinking water system, toilets against frost. Prevents the formation of lime scum, does not affect rubber, plastics and metals. Also suitable for engines with alu-coolers and alu-cylinder covers. Non-toxic and biodegradable.

Artikel Nr.	Inhalt
No d'articolo	Contenu
No d'article	Contenuto
Article No	Contents
11007-6	5 l
11007-20	20 l

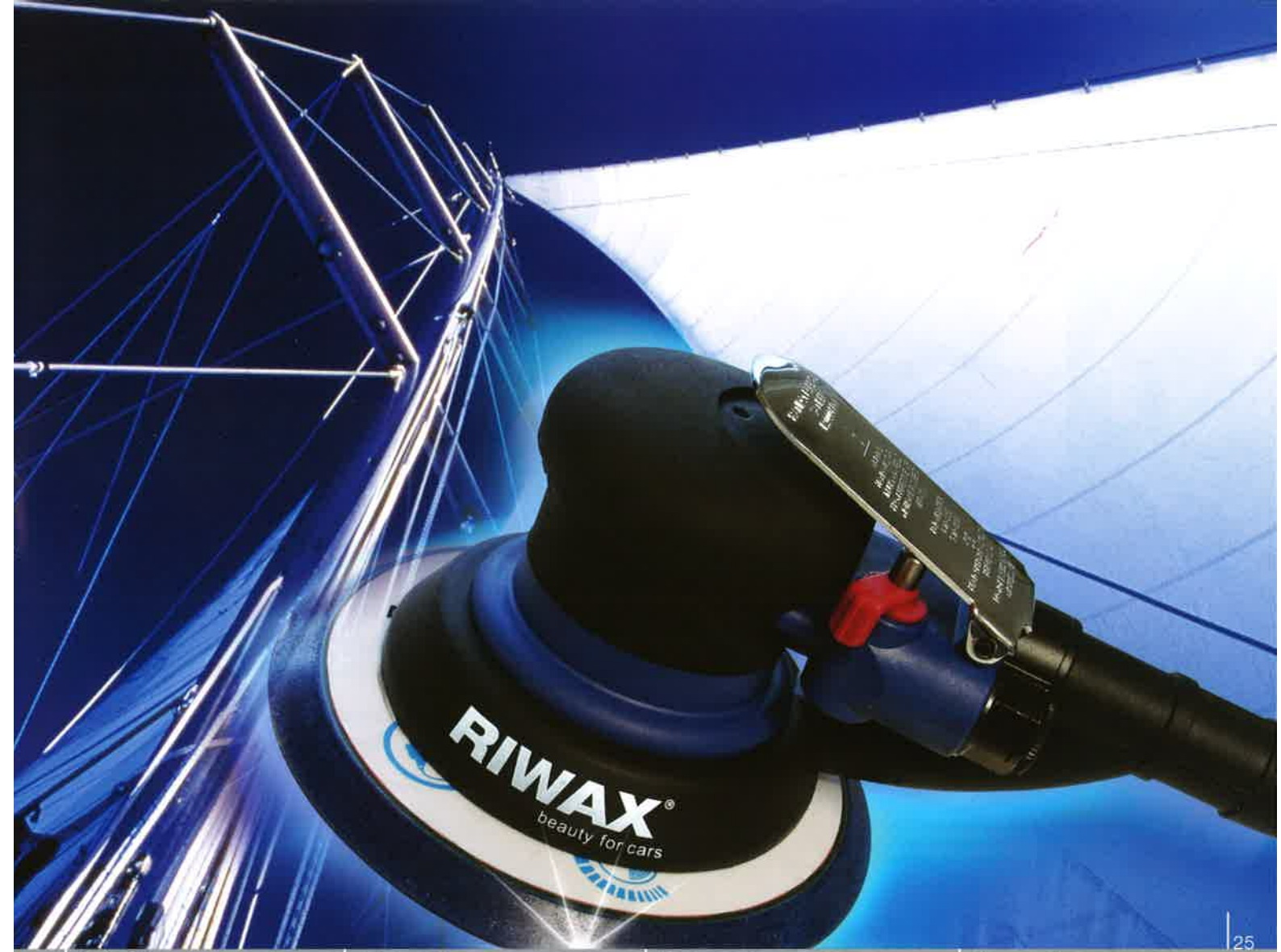

Zubehör

Accessoires

Accessori

Accessoires



**LAMMFELL**

75mm / 165mm / 200mm

Zum Polieren von 1200er – 3000er Schleifspuren, besseres Schleifpolieren, schneller, geringe Wärmebildung, Klettverbindung.

225 mm (9")
VELCRO ODER DOPPELSEITIG

Für Tiefenreinigung und exzellenten Finish.

PEAU DE MOUTON

75mm / 165mm / 200mm

Élimination de traces de polissage de grain 1200 à 3000, meilleur polissage, plus rapide, dégagement moindre de chaleur, raccord velcro.

225 mm (9")
VELCRO OU DOUBLE FACE

Nettoie en profondeur et ressure une excellente finition.

**ZWISCHENSCHWAMM**

75mm / 150mm / 175mm

Klett- Adapter für Fell (beidseitig), biegsam, weich.

ADAPTATEUR INTERMEDIAIRE

75mm / 150mm / 175mm

Adaptateur velcro pour peaux (sur les deux faces), souple, douce.

**POLIERSCHWAMM BLAU**

(HART) 85 x 30mm / 175 x 30mm / 240 x 40mm

Universell zum Schleifpolieren. Nimmt Politur auf, verhindert Spritzen, gute Führung, geringe Wärmebildung.

MOUSSE A POLIR BLEU

(DURE) 85 x 30mm / 175 x 30mm / 240 x 40mm

Utilisation universelle pour tout polissage. Absorbe le lustrant, empêche les éclaboussures, facile à manier, génère peu de chaleur.

**POLIERSCHWAMM WEISS**

(MITTEL) 85 x 30mm / 175 x 30mm / 240 x 40mm

Universell einsetzbar. Polieren, Hochglanz und Wachsen, nimmt Politur auf, verhindert Spritzen, geringe Wärmebildung.

MOUSSE A POLIR BLANCHE

(MOYENNE) 85 x 30mm / 175 x 30mm / 240 x 40mm

À utilisation universelle. Polissage, brillance et cirage. Absorbe le lustrant, empêche les éclaboussures, génère peu de chaleur.

DISCO D'AGNELLO

75mm / 165mm / 200mm

Lucidatura di rigature di rettifica della grana 1200 – 3000, migliore levigatura/lucidatura, più veloce, scarso riscaldamento, fissaggio a velcro.

225 mm (9 ")
VELCRO O DOPPIA FACCIA

Per una pulitura di profondità et una finitura eccellente.

LAMBSKIN

75mm / 165mm / 200mm

Polishing out traces from 1200- to 3000-grit sandpaper, better sander polishing, faster, low heat generation, Velcro fastener.

225 mm (9 ")
VELCRO OR DOUBLE SIDED

For deep cleaning and an excellent finish.

Artikel Nr.	Inhalt
No d'articolo	Contenu
No d'article	Contenuto
Article No	Contents
11576-S (75mm)	5 Stück / pièce / pz.
11576-M (165mm)	5 Stück / pièce / pz.
11576-L (200mm)	5 Stück / pièce / pz.
11576-XLV	5 Stück / pièce / pz.
11576-XLD	5 Stück / pièce / pz.

TAMPONE INTERMEDIO

75mm / 150mm / 175mm

Tampone velcro per cuffia (a due lati), flessibile, morbido.

INTERMEDIATE SPONGE

75mm / 150mm / 175mm

With Velcro adaptor for lambskin (both sides). Flexible, soft.

Artikel Nr.	Inhalt
No d'articolo	Contenu
No d'article	Contenuto
Article No	Contents
11577-S (75mm)	1 Stück / pièce / pz.
11577-M (150mm)	1 Stück / pièce / pz.
11577-L (175mm)	1 Stück / pièce / pz.

TAMPONE PER LUCIDATURA

BLU (DURO) 85 x 30mm / 175 x 30mm / 240 x 40mm

Universale per levigatura/lucidatura, assorbe il polish, impedisce gli schizzi, maneggevole, scarso riscaldamento.

BLUE POLISHING SPONGE

(HARD) 85 x 30mm / 175 x 30mm / 240 x 40mm

For all sander polishing. Absorbs polish, prevents spraying, good handling, low heat generation.

Artikel Nr.	Inhalt
No d'articolo	Contenu
No d'article	Contenuto
Article No	Contents
11570-S (85 x 30mm)	1 Stück / pièce / pz.
11570-M (175 x 30mm)	1 Stück / pièce / pz.
11570-L (240 x 40mm)	1 Stück / pièce / pz.

TAMPONE PER LUCIDATURA

BLANCO (MEDIO) 85 x 30mm / 175 x 30mm / 240 x 40mm

Uso universale. Per lucidatura, lucidatura a specchio e ceratura, assorbe il polish, impedisce gli schizzi, scarso riscaldamento.

WHITE POLISHING SPONGE

(MEDIUM) 85 x 30mm / 175 x 30mm / 240 x 40mm

All-round use: polishing, high gloss and waxing. Absorbs polish, prevents spraying, low heat generation.

Artikel Nr.	Inhalt
No d'articolo	Contenu
No d'article	Contenuto
Article No	Contents
11571-S (85 x 30mm)	1 Stück / pièce / pz.
11571-M (175 x 30mm)	1 Stück / pièce / pz.
11571-L (240 x 40mm)	1 Stück / pièce / pz.



POLIERSCHWAMM SCHWARZ (SOFT)
175 x 30mm / 240 x 40mm

Weicher Schwamm, hinterlässt keine Spuren, für Hochglanz, zum Wachsen und Abpolieren, erwärmt den Lack nicht.

MOUSSE A POLIR NOIRE (DOUCE)
175 x 30mm / 240 x 40mm

Éponge douce, ne laisse aucune trace, Brillance, cirage, dépolissage, Ne chauffe pas la peinture.



MICROFASERHAUBE (FROTTEE)

Zur Anwendung auf Polierschwamm mit Orbital Polisher, zum Abpolieren, gute Saugkraft, keine Hologrammbildung.

CAPOT MICROFIBRE (BOUCLE)

Sur éponge à polir avec Orbital, pour lustrer meilleure absorption, évite la formation d'hologrammes.



MICROFASERTUCH (FROTTEE) 40 x 40cm

High-Tech Tuch für alle Oberflächen, gute Saugkraft, für porentiefe Reinigung, kratzt nicht.

CHIFFON MICROFIBRE (BOUCLE) 40 x 40cm

Chiffon high-tech pour toutes surfaces, meilleure absorption, nettoyage en profondeur, ne raye pas.



POLIERTÜCHER

Einweg-Poliertuch, zum Polieren und Reinigen, Kratzt nicht, fusselfrei, extra weich.

CHIFFONS A POLIR

Chiffon jetable pour polir et nettoyer, Ne raye pas, ne peluche pas, extra doux.

TAMPONE PER LUCIDATURA NERO (SOFT) 175 x 30mm / 240 x 40mm

Tampone morbido, non lascia segni, lucidatura a specchio, ceratura, finitura. Non scalda la vernice.

BLACK POLISHING SPONGE (SOFT) 175 x 30mm / 240 x 40mm

Soft sponge that leaves no traces. High gloss, waxing, polishing up. Does not heat up the paintwork.

Artikel Nr.	Inhalt
No d'articolo	Contenu
No d'article	Contenuto
Article No	Contents
11572-M (175 x 30mm)	1 Stück / pièce / pz.
11572-L (240 x 40mm)	1 Stück / pièce / pz.

CUFFIA IN MICROFIBRA (TESSUTO SPUGNA)

Da usare sul tampone per lucidatura con lucidatrice orbitale, per la finitura, migliore assorbenza, nessuna formazione d'ologrammi.

MICROFIBRE COVER (TOWELLING)

For polishing sponges on orbital polishers. For polishing up. Better absorption, no hologram traces.

Artikel Nr.	Inhalt
No d'articolo	Contenu
No d'article	Contenuto
Article No	Contents
11575	5 Stück / pièce / pz.

PANNO IN MICROFIBRA (TESSUTO SPUGNA) 40 x 40cm

Panno high-tech per tutte le superfici, migliore assorbenza, pulitura in profondità, non graffia.

MICROFIBRE CLOTH (TOWELLING) 40 x 40cm

High-tech cloth for all surfaces. Better absorption, pore-deep cleaning. Does not scratch.

Artikel Nr.	Inhalt
No d'articolo	Contenu
No d'article	Contenuto
Article No	Contents
05578	1 Stück / pièce / pz.

PANNI PER LUCIDARE

Panno lucidante monouso per lucidare e pulire. Non graffia, non lascia pelucchi, extra morbido.

POLISHING CLOTHS

Disposable cloths for polishing and cleaning. No scratching, no pilling, extra-soft.

Artikel Nr.	Inhalt
No d'articolo	Contenu
No d'article	Contenuto
Article No	Contents
04065	400 x



NASSSCHLEIFPAPIER P1500 / P2000 / P2500

Speziell ausgesuchtes Spot Repair und Finishpapier zum Anschleifen, Defekte ausschleifen, grosse Flächen bearbeiten.

PAPIER-EMERI HUMIDE P1500 / P2000 / P2500

Kit réparation et papier finition spécialement sélectionnés pour les travaux préparatifs de polissage, pour éliminer les défauts de polissage, pour le traitement de grandes surfaces.



SCHLEIFSUPPORT

Unterlage für Schleifpapier. Handlich und beweglich, passt sich den Konturen an. (70 x 140 x 10mm)

SUPPORT DE POLISSAGE

Support pour papier-émeri. Facile à manier et souple, s'adapte aux contours. (70 x 140 x 10mm)



RIWAX POLISHER

Handlich, regulierbar, 1300 W, 220 V, 800 – 2400 U/min. M14.

MACHINE A POLIR RIWAX

Facile à manier, réglable, 1300 W, 220 V, 800 – 2400 t/min. M 14.



RIWAX POLISHER PROFESSIONAL

Hochwertige Präzisionspoliermaschine, 1200 W, 220 V, 600-3000 U/min. M 14.

RIWAX POLISHER PROFESSIONNELLE

Ponceuse de précision de grande qualité, 1200 W, 220 V, 600-3000 t/min. M 14.



**CARTA ABRASIVA A UMIDO
P1500 / P2000 / P2500**

Carta speciale selezionata Spot Repair e finitura per preparare la levigatura, levigare i difetti, trattare grandi superfici.

**WET SANDPAPER
P1500 / P2000 / P2500**

Specially selected spot repair and finishing paper. Sanding, sanding out defects, working on large surfaces.

Artikel Nr.	Inhalt
No d'articolo	Contenu
No d'article	Contenuto
Article No	Contents
11586 (P1500) A6	50 Stück / pièce / pz.
11587 (P2000) A6	50 Stück / pièce / pz.
11588 (P2500) A6	50 Stück / pièce / pz.

SUPPORTO DI LAVIGATURA

Base per carta abrasive. Maneggevole e flessibile si adatta ai contorni.
(70 x 140 x 10mm)

SANDPAPER SUPPORT

Pad for sandpaper. Handy and flexible. Adapts to contours.
(70 x 140 x 10mm)

Artikel Nr.	Inhalt
No d'articolo	Contenu
No d'article	Contenuto
Article No	Contents
11589	5 Stück / pièce / pz.

RIWAX LUCIDATRICE

Maneggevole, regolabile, 1300 W, 220 V, 800 – 2400 giri/min. M 14.

RIWAX POLISHER

Handy, adjustable, 1300 W, 220 V, 800–2400 R/min. M 14.

Artikel Nr.	Inhalt
No d'articolo	Contenu
No d'article	Contenuto
Article No	Contents
05511	1 Stück / pièce / pz.

**RIWAX POLISHER
PROFESSIONALE**

Macchina di lucidatura di precisione di alta qualità.
1200 W, 220 V, 600-3000 giri/min. M 14.

**RIWAX POLISHER
PROFESSIONAL**

High-quality precision polishing machine.
1200 W, 220 V, 600-3000 R/min. M 14.

Artikel Nr.	Inhalt
No d'articolo	Contenu
No d'article	Contenuto
Article No	Contents
05509	1 Stück / pièce / pz.



STÜTZTELLER FÜR POLISHER
75mm / 150mm / 175mm

Klettverschluss, geschäumt, M 14.

**SUPPORT POUR MACHINE
A POLIR**
75mm / 150mm / 175mm

Fermeture velcro, mousse, M 14.



**RIWAX EXCENTER ORBITAL
ELEKTRO**

Zum Schleifen, Wachsen und Entwachsen.
Handlich, schnell, zeitsparend (elektrisch)

**POLISSEUSE ORBITAL
ELECTRIQUE RIWAX**

Pollissage, cirage, décirage. Facile à manier,
rapide, garantit une économie de temps
(électrique).



**ORBITAL POLISHER
150mm**

Pneumatisch, einfache Anwendung, variabel
einsetzbar. Verursacht keine Hologramm-
bildungen, zeitsparend, zum Polieren, Wachsen
und Entwachsen.

Min. 6 bar Luft.

**ORBITAL POLISHER
150mm**

Pneumatique, utilisation facile et variable.
Aucune formation d'hologrammes, économie
de temps, polissage, cirage et décirage.

Au moins 6 bars d'air.



**ORBITAL POLISHER
75mm, Hub 2,5mm**

Pneumatisch, Spot Repair, zum Entfernen von
Staubeschlüssen, Orangenhaut und Lackde-
fekten. Handlich, gleichmässiges Schleifbild.

**ORBITAL POLISHER
75mm, levée 2,5mm**

Kit réparation pour éliminer les inclusions de
poussière, les «peaux de crocodile» et les
défauts de peinture. Facile à manier, polissage
régulier.

PLATORELLO PER LUCIDATRICE
75mm / 150mm / 175mm

Attacco velcro, in schiuma espansa. M 14.

SUPPORT PLATE FOR POLISHER
75mm / 150mm / 175mm

Velcro fastener, foam backing. M 14.

Artikel Nr.	Inhalt
No d'articolo	Contenu
No d'article	Contenuto
Article No	Contents
05521 (75mm)	1 Stück / pièce / pz.
05520 (150mm)	1 Stück / pièce / pz.
05522 (175mm)	1 Stück / pièce / pz.

LUCIDATRICE ELETTRICA
ORBITALE RIWAX

Per lucidare, cerare, decerare. Maneggevole, più veloce, fa risparmiare tempo (elettrico).

RIWAX EXCENTER ORBITAL
ELECTRIC

Polishing, waxing, wax removal. Handy, faster, saves time (electric).

Artikel Nr.	Inhalt
No d'articolo	Contenu
No d'article	Contenuto
Article No	Contents
05706	1 Stück / pièce / pz.

LUCIDATRICE ORBITALE
150mm

Pneumatica, semplice da usare, versatile. Non provoca formazioni di ologrammi, fa risparmiare tempo, per lucidare, cerare e decerare.

Aria min. 6 bar.

ORBITAL POLISHER
150mm

Pneumatic, simple to use, versatile. Leaves no hologram traces, saves time. Polishing, waxing and wax removal.

Min. 6 bar air pressure.

Artikel Nr.	Inhalt
No d'articolo	Contenu
No d'article	Contenuto
Article No	Contents
05700	1 Stück / pièce / pz.

LUCIDATRICE ORBITALE
75mm, corsa 2,5mm

Spot Repair per l'eliminazione di inclusioni di polvere, effetto buccia d'arancia e difetti di verniciatura. Maneggevole, aspetto omogeneo della levigatura.

ORBITAL POLISHER
75mm, hub 2,5mm

Spot repair to remove embedded dust, orange peel and paint defects. Handy. For even sanding.

Artikel Nr.	Inhalt
No d'articolo	Contenu
No d'article	Contenuto
Article No	Contents
05705	1 Stück / pièce / pz.

**PAD WASHER**

Reinigt alle Schwämme und Felle. Saubere angefeuchtete Schwämme und Felle, zeitsparend.

PAD WASHER

Nettoie toutes éponges et peaux. Éponges et peaux propres et humectées, économie de temps.

**PLASTIKBEHÄLTER
ZU POLIERSET BLAU**

Für das Poliermaterial.
Sorgt für Ordnung.

**BOITE RANGEMENT RIWAX
BLEUE**

Pour le matériel de polissage, etc.
Permet de tout bien ranger.

**BOOT-PFLEGE-BOY**

Mit dem praktischen, beweglichen Wagen sind alle Materialien und Maschinen jederzeit griffbereit.

**CHARIOT POUR L'ENTRETIEN
DE BATEAUX**

Grâce à ce chariot pratique et mobile, tout le matériel et toutes les machines sont à portée de la main à tout moment.

**10-LITER WASCHEIMER****SEAU 10 l**

PAD WASHER

Pulisce tutti i tipi di spugne e dischi di lana.
Spugne e dischi puliti e inumiditi,
fa risparmiare tempo.

PAD WASHER

Cleans all sponges and fleeces.
For clean, moist sponges and fleeces.
Saves time.

Artikel Nr.	Inhalt
No d'articolo	Contenu
No d'article	Contenuto
Article No	Contents
05573	1 Stück / pièce / pz.

**VALIGETTA RIWAX
BLU**

Per materiale di lucidatura ecc.
Per tenere in ordine.

BLUE RIWAX BOX

For polishing materials, etc.
Keeps things tidy.

Artikel Nr.	Inhalt
No d'articolo	Contenu
No d'article	Contenuto
Article No	Contents
05706	1 Stück / pièce / pz.

**CARRELLO PER PULIZIA
BARCHE**

Con il pratico carrello mobile tutti i materiali
e gli apparecchi sono sempre a portata di mano.

BOAT CARE TROLLEY

All materials and equipment are at hand at all
times thanks to this practical, mobile trolley.

Artikel Nr.	Inhalt
No d'articolo	Contenu
No d'article	Contenuto
Article No	Contents
05510	1 Stück / pièce / pz.

SECCHIO 10 l**BUCKET 10 l**

Artikel Nr.	Inhalt
No d'articolo	Contenu
No d'article	Contenuto
Article No	Contents
04024	1 Stück / pièce / pz.



WASCHHANDSCHUH

GANT A LAYER



MESSBECHER

VERRE MESUREUR



PLASTIK-SPRAYER

PULVERISATEUR PLASTIC



ARBEITSFLASCHE KLEIN

BOUTEILLE DE TRAVAIL PETITE

GUANTO PER LAVAGGIO

WASHING GLOVE

Artikel Nr.	Inhalt
No d'articolo	Contenu
No d'article	Contenuto
Article No	Contents
04055	1 Stück / pièce / pz.

MISURINO

MEASURE CUP

Artikel Nr.	Inhalt
No d'articolo	Contenu
No d'article	Contenuto
Article No	Contents
04035	1 Stück / pièce / pz.

SPRUZZATORE PLASTICA

PLASTIC-SPRAYER

Artikel Nr.	Inhalt
No d'articolo	Contenu
No d'article	Contenuto
Article No	Contents
04010-1	1 Stück / pièce / pz.

FLACONE PICCOLA

WORKING BOTTLE SMALL

Artikel Nr.	Inhalt
No d'articolo	Contenu
No d'article	Contenuto
Article No	Contents
04007-1	1 Stück / pièce / pz.

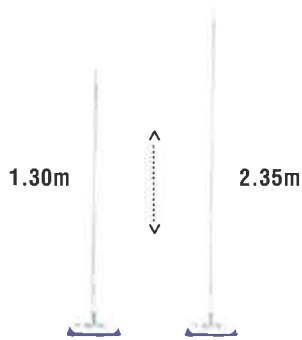

ALUMINIUMTELESKOPSTIEL

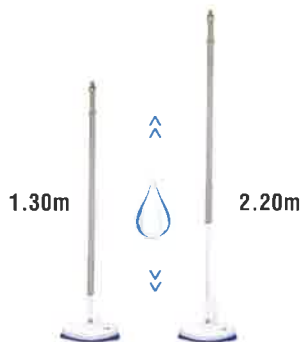
MANCHE TELESCOPIQUE
D'ALUMINIUMWASCHBÜRSTE
MIT METALLFASSUNG
25cmBROSSE
AVEC MONTURE EN MÉTAL
25cmALUMINIUM / KUNSTSTOFF-
TELESKOPSTIEL
FÜR DURCHFLUSSMANCHE TELESCOPIQUE
EN ALUMINIUM ET PLASTIQUE
POUR L'ÉCOULEMENT DE L'EAUWASCHBÜRSTE
MIT KUNSTSTOFFFASSUNG
FÜR DURCHFLUSS
25cmBROSSE
AVEC MONTURE EN PLASTIC
POUR L'ÉCOULEMENT DE L'EAU
25cm

**MANICO TELESCOPICO
D'ALLUMINIO**

**TELESCOPIC ANODISED
ALUMINIUM HANDLE**

Artikel Nr.	Inhalt
No d'articolo	Contenu
No d'article	Contenuto
Article No	Contents
06003	1 Stück / pièce / pz.

**SPAZZOLA
CON MONTATURA DI METALLO
25cm**

**BOATBRUSH
WITH METAL SOCKET
25cm**

Artikel Nr.	Inhalt
No d'articolo	Contenu
No d'article	Contenuto
Article No	Contents
06002	1 Stück / pièce / pz.

**MANICO TELESCOPICO
D'ALLUMINIO E PLASTICA
PER IL FUSO DELL'ACQUA**

**TELESCOPIC ALUMINIUM /
PLASTIC HANDLE
FOR WATERFLOW**

Artikel Nr.	Inhalt
No d'articolo	Contenu
No d'article	Contenuto
Article No	Contents
06004	1 Stück / pièce / pz.

**SPAZZOLA
CON MONTATURA DI PLASTICA
PER IL FUSO DELL'ACQUA
25cm**

**BOATBRUSH
WITH PLASTIC SOCKET
FOR WATER FLOW
25cm**

Artikel Nr.	Inhalt
No d'articolo	Contenu
No d'article	Contenuto
Article No	Contents
06001	1 Stück / pièce / pz.



RIWAX[®]
beauty for cars

RIWAX-Chemie AG
Tannholzstrasse 3
CH-3052 Zollikofen
Tel. +41 (0)31 910 45 45
Fax +41 (0)31 910 45 05
office.ch@riwax.com
www.riwax.com